

THIS IS A C.A.D. GENERATED DRAWING
DO NOT MAKE MANUAL REVISIONS TO MASTER.



UNLESS OTHERWISE SPECIFIED TOLERANCES
ON DECIMAL IS: ANGLE
UNIT: MM X.
X.X

1) Product main performance:
Operating Temperature : -55°C~150°C
Humidity(max) : <=95% [at 60 deg C / 140 F]
Salt Spray Corrosion: 96hr

Mechanical data:
Configuration: 2P series, low voltage
Contact type: Soldering
Vibration : 15g[10Hz~2000Hz]
Endurance (Shell) : ≥1000+

Other Specification:
Contact PIN : Gold plated Tin bronze
Housing material: PSU
Other Shell Material: PSU
Insulator material: PPS
IP Rating : IP50
*ALL MATERIALS ARE RoHS COMPLIANT.

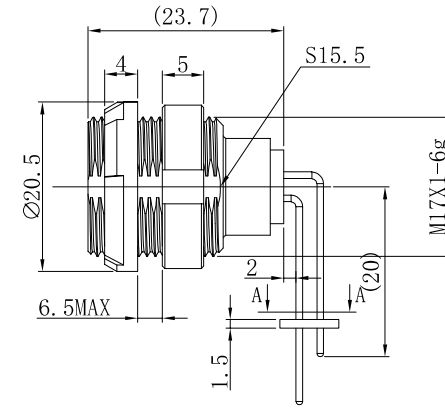
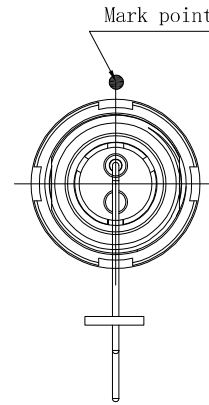

Pin Configuration	02	03	04	05	06	07	08
Pin Number							
Pin Size (mm)	2.0	1.6	1.3	1.3	1.3	1.3	0.9
Withstand voltage (V) (AC)	2100	2400	1850	1750	1350	1750	1500
Rated Current (A)	30.0	17.0	15.0	14.0	12.0	11.0	10.0
Insulation resistance (MΩ)	≥5000MΩ (500V(DC))						
R (max) (mΩ)	≤3.5	≤4	≤5	≤5	≤5	≤5	≤9

MHCP2PxxRD

Pin Configuration

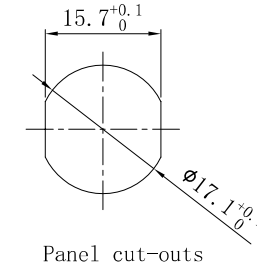

Panel cut-outs

THESE DRAWINGS AND SPECIFICATIONS ARE THE PROPERTY OF MH CONNECTORS AND SHALL NOT BE REPRODUCED, COPIED OR USED AS THE BASIS FOR THE MANUFACTURE OR SALE OF APPARATUS WITHOUT WRITTEN PERMISSION.

DRAWN E.P. DATE 23-10-23

APPROVED S.R. DATE 23-10-23

SCALE NA SHEET OF 1 OF 4 REV: 2

DRAWING No MHCP2PxxRD



THIS SERIES FULLY CONFORMS TO THE EUROPEAN UNION DIRECTIVES 2015/863/EU AND 2011/65/EU FOR RoHS COMPLIANCY.



MH CONNECTORS,
DIVISION OF EDAC

THIS IS A C.A.D. GENERATED DRAWING
DO NOT MAKE MANUAL REVISIONS TO MASTER.



UNLESS OTHERWISE SPECIFIED TOLERANCES
ON DECIMAL IS: ANGLE
UNIT: MM X.
X.X

1) Product main performance:
Operating Temperature : -55°C~150°C
Humidity(max) : <=95% [at 60 deg C / 140 F]
Salt Spray Corrosion: 96hr

Mechanical data:
Configuration: 2P series, low voltage
Contact type: Soldering
Vibration : 15g[10Hz~2000Hz]
Endurance (Shell) : ≥1000+

Other Specification:
Contact PIN : Gold plated Tin bronze
Housing material: PSU
Other Shell Material: PSU
Insulator material: PPS
IP Rating : IP50
*ALL MATERIALS ARE RoHS COMPLIANT.

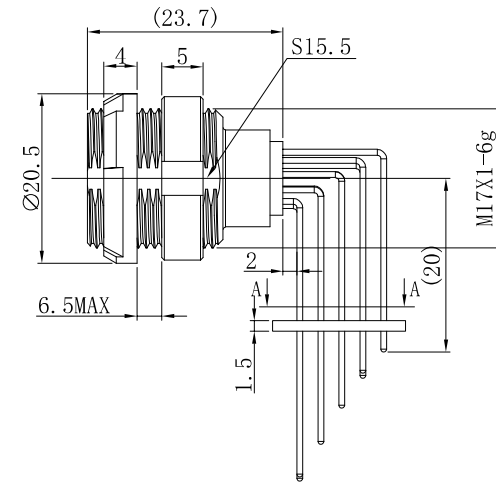
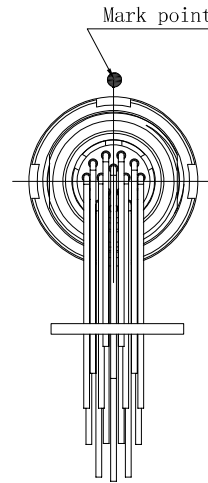

Pin Configuration	10	12	16	19	26
Pin Number					
Pin Size (mm)	0.9	0.7	0.7	0.7	0.5
Withstand voltage (V) (AC)	1450	1250	1500	1400	1000
Rated Current (A)	8.0	7.0	6.0	5.0	2.0
Insulation resistance (MΩ)	≥5000MΩ (500V (DC))				
R (max) (mΩ)	≤9	≤12.5	≤12.5	≤12.5	≤15

MHCP2PxxRD

Pin Configuration

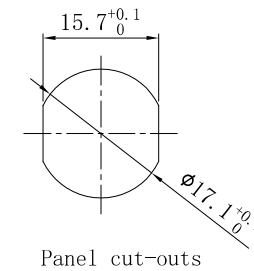

Panel cut-outs

THESE DRAWINGS AND SPECIFICATIONS ARE THE PROPERTY OF MH CONNECTORS AND SHALL NOT BE REPRODUCED, COPIED OR USED AS THE BASIS FOR THE MANUFACTURE OR SALE OF APPARATUS WITHOUT WRITTEN PERMISSION.

DRAWN E.P. DATE 23-10-23

APPROVED S.R. DATE 23-10-23

SCALE NA SHEET OF 2 OF 4 REV: 2

DRAWING No MHCP2PxxRD



THIS SERIES FULLY CONFORMS TO THE EUROPEAN UNION DIRECTIVES 2015/863/EU AND 2011/65/EU FOR RoHS COMPLIANCY.



MH CONNECTORS,
DIVISION OF EDAC

THIS IS A C.A.D. GENERATED DRAWING
DO NOT MAKE MANUAL REVISIONS TO MASTER.

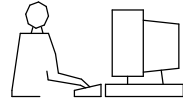

UNLESS OTHERWISE SPECIFIED TOLERANCES
ON DECIMAL IS: ANGLE
UNIT: MM X.
X.X

2P PCB cut-outs (A-A)

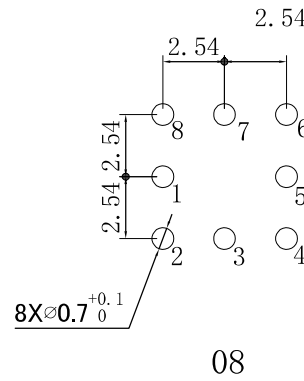
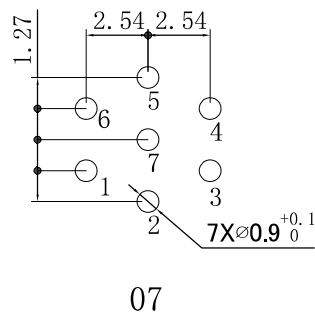
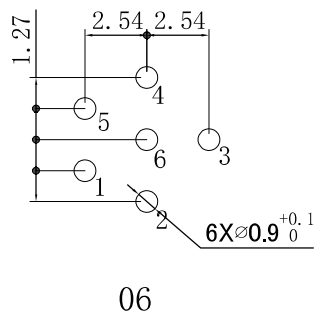
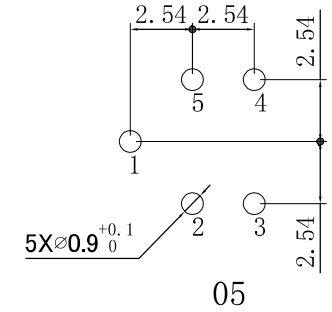
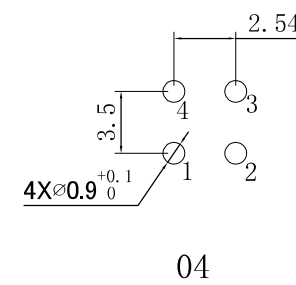
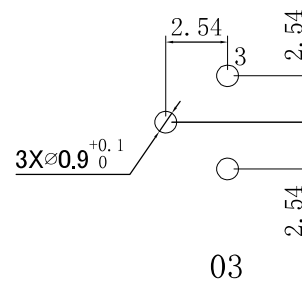
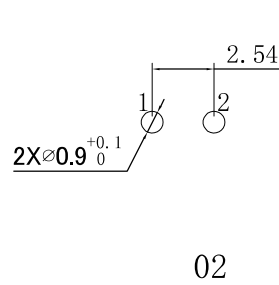
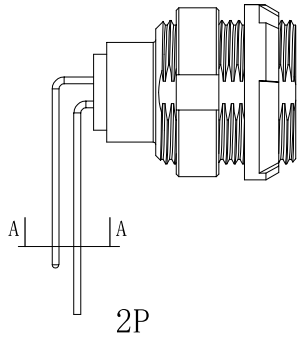

THESE DRAWINGS AND SPECIFICATIONS ARE THE PROPERTY OF MH CONNECTORS AND SHALL NOT BE REPRODUCED, COPIED OR USED AS THE BASIS FOR THE MANUFACTURE OR SALE OF APPARATUS WITHOUT WRITTEN PERMISSION.

DRAWN	E.P.	DATE
		23-10-23

APPROVED	S.R.	DATE
		23-10-23

SCALE	SHEET OF	REV:
NA	3 OF 4	2

DRAWING No	MHCP2PxxRD
------------	------------



THIS SERIES FULLY CONFORMS TO THE EUROPEAN UNION DIRECTIVES 2015/863/EU AND 2011/65/EU FOR RoHS COMPLIANCY.



MH CONNECTORS,
DIVISION OF EDAC

THIS IS A C.A.D. GENERATED DRAWING
DO NOT MAKE MANUAL REVISIONS TO MASTER.

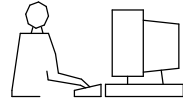

UNLESS OTHERWISE SPECIFIED TOLERANCES
ON DECIMAL IS: ANGLE
UNIT: MM X.
X.X

2P PCB cut-outs (A-A)

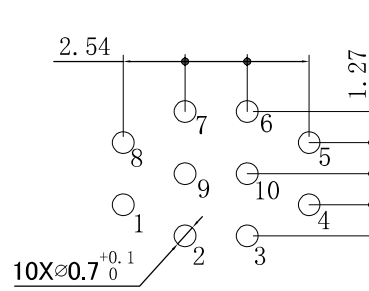
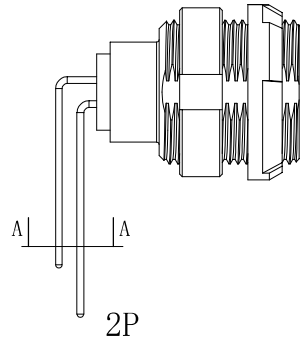

10

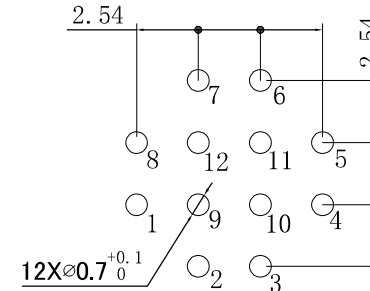

12

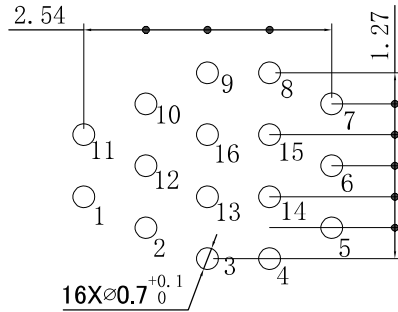

16

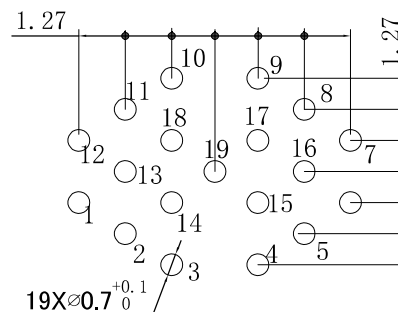

19

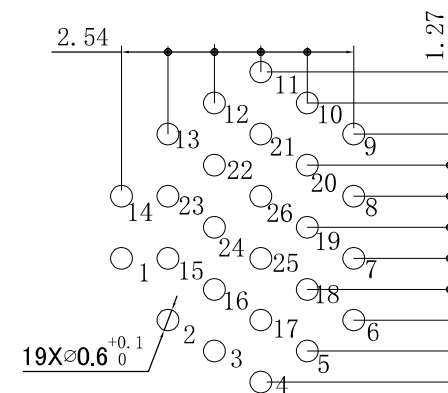

26

THESE DRAWINGS AND SPECIFICATIONS ARE THE PROPERTY OF MH CONNECTORS AND SHALL NOT BE REPRODUCED, COPIED OR USED AS THE BASIS FOR THE MANUFACTURE OR SALE OF APPARATUS WITHOUT WRITTEN PERMISSION.

DRAWN	E.P.	DATE
		23-10-23

APPROVED	S.R.	DATE
		23-10-23

SCALE	SHEET OF	REV:
NA	4 OF 4	2

DRAWING No	MHCP2PxxRD
------------	------------



THIS SERIES FULLY CONFORMS TO THE EUROPEAN UNION DIRECTIVES 2015/863/EU AND 2011/65/EU FOR RoHS COMPLIANCY.



MH CONNECTORS,
DIVISION OF EDAC